



RUTX12

Quick Start Guide v1.0



Wiki knowledge base

<https://wiki.teltonika-networks.com/>



FRONT VIEW

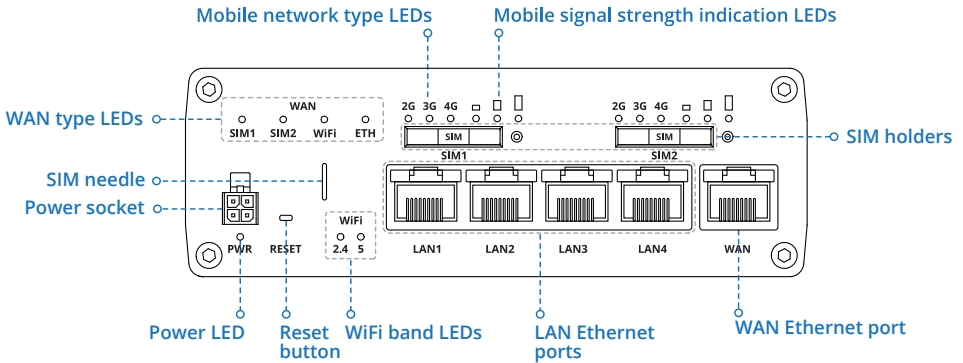

BACK VIEW

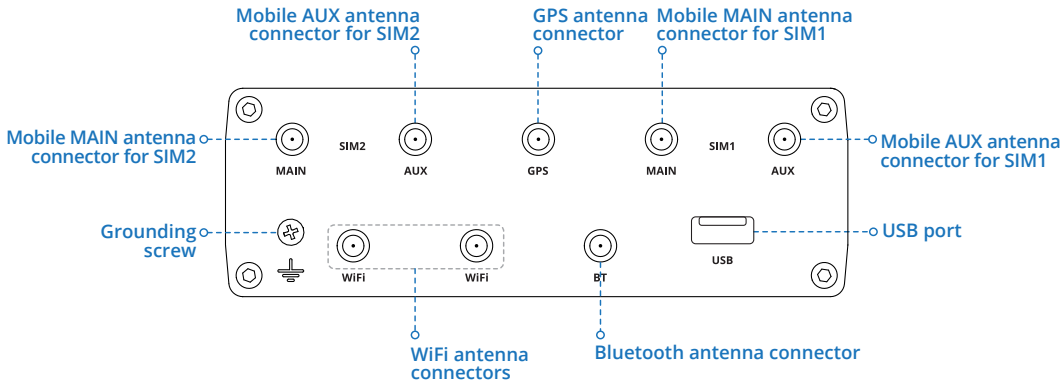

POWER SOCKET PINOUT

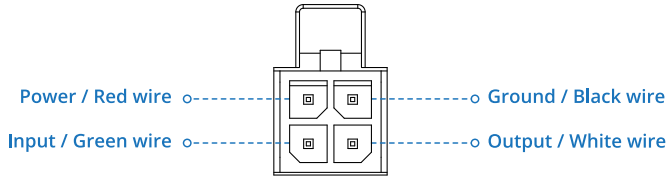

HARDWARE INSTALLATION

1. Pull out the SIM needle from the front panel of the router.
2. Push the SIM holder button with the SIM needle.
3. Pull out the SIM holder.
4. Insert your SIM card into the SIM holder.
5. Slide the SIM holder back into the router.
6. Attach all antennas.
7. Connect the power adapter to the socket on the front of the device. Then plug the other end of the power adapter into a power outlet.
8. Connect to the device wirelessly using SSID and password provided on the device information label or use an Ethernet cable connected to LAN port.

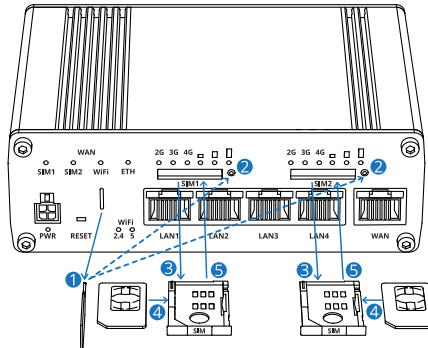

LOGIN TO DEVICE

1. To enter the router's Web interface (WebUI), type <http://192.168.1.1> into the URL field of your Internet browser.
2. Use login information shown in image A when prompted for authentication.
3. After you log in, you will be prompted to change your password for security reasons. The new password must contain at least 8 characters, including at least one uppercase letter, one lowercase letter, and one digit. This step is mandatory, and **you will not be able to interact with the router's WebUI before you change the password.**
4. When you change the router's password, the **Configuration Wizard** will start. The **Configuration Wizard** is a tool used to set up some of the router's main operating parameters.
5. Go to the **Overview** page and pay attention to the **Signal Strength** indication (image B). To maximize the cellular performance try adjusting the antennas or changing the location of your device to achieve the best signal conditions.

A.

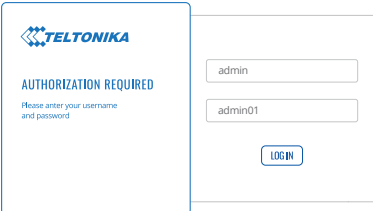

 **TELTONIKA**

AUTHORIZATION REQUIRED
Please enter your username and password

admin

admin01

LOGIN

B.



MOBILE  -65 dBm

Data connection state Connected

State Registered (home); OPERATOR; 4G (LTE)

SIM card slot in use Ready

Bytes received/sent* 348.7 KB / 223.5 KB

TECHNICAL INFORMATION

Radio specifications	
RF technologies	3G, 4G, GNSS, WiFi, BLE
Max RF power	24 dBm@WCDMA, 23 dBm@LTE, 23 dBm@WiFi 10 dBm@BLE
Bundled accessories specifications*	
Power adapter	Input: 0.6 A@100-240 VAC, Output: 12 VDC, 1.5 A, 4 pin plug
Mobile antenna	698-960/1710-2690 MHz, 50 Ω, VSWR<3, gain** 3 dBi, omnidirectional, SMA male connector
GNSS antenna	1575.42-1602 MHz, 2.2-5 VDC, VSWR<1.5, active total gain** 28 dB (typ.), RHCP polarization, SMA male connector
WiFi antenna	2400-2500 MHz/4950-5850 MHz, 50 Ω, VSWR<2, gain** 3 dBi, omnidirectional, RP-SMA male connector
BLE antenna	2400-2500 MHz, 50 Ω, VSWR<2.5, gain** 2.5 dBi, omnidirectional, RP-SMA male connector

*Order code dependent.

**Higher gain antenna can be connected to compensate for cable attenuation when a cable is used. The user is responsible for the compliance with the legal regulations.

SAFETY INFORMATION

RUTX12 router must be used in compliance with any and all applicable national and international laws and with any special restrictions regulating the utilization of the communication module in prescribed applications and environments.

[EN] English	Hereby, TELTONIKA declares that this RUTX12 is in compliance with the essential requirements and other relevant provisions of Directive CE/RED.
[BG] Bulgarian	С настоящето, TELTONIKA декларира, че RUTX12 е в съответствие със съществените изисквания и другите приложими разпоредби на Директива CE/RED.
[CZ] Czech	TELTONIKA tímto prohlašuje, že RUTX12 splňuje základní požadavky a všechna příslušná ustanovení Směrnice CE/RED.
[DE] German	Hiermit erklärt TELTONIKA dass sich das Gerät RUTX12 in Übereinstimmung mit den grundlegenden Anforderungen und den übrigen einschlägigen Bestimmungen der Richtlinie CE/RED befindet.
[DK] Danish	Undertegnede TELTONIKA erklærer herved, at følgende udstyr RUTX12 overholder de væsentlige krav og øvrige relevante krav i direktiv CE/RED.
[EE] Estonian	Käesolevaga kinnitab TELTONIKA seadme RUTX12 vastavust direktiivi CE/RED põhinõuetele ja nimetatud direktiivist tulenevatele teistele asjakohastele sätetele.
[ES] Spanish	Por la presente, TELTONIKA declara que este RUTX12 cumple con los requisitos esenciales y otras exigencias relevantes de la Directiva CE/RED.
[FI] Finnish	TELTONIKA vakuuttaa täten että RUTX12 tyyppinen laite on direktiivin CE/RED oleellisten vaatimusten ja sitä koskevien direktiivin muiden ehtojen mukainen.
[FR] French	TELTONIKA déclare que cette RUTX12 est conforme aux exigences essentielles et aux autres dispositions pertinentes de la directive CE /RED.
[GR] Greek	ΜΕ ΤΗΝ ΠΑΡΟΥΣΑ Ο ΚΑΤΑΣΚΕΥΑΣΤΗΣ ΤΕΛΤΟΝΙΚΑ ΔΗΛΩΝΕΙ ΟΤΙ Η ΡUTX12 ΣΥΜΜΟΡΦΩΝΕΤΑΙ ΠΡΟΣ ΤΙΣ ΟΥΣΙΩΔΕΙΣ ΑΠΑΙΤΗΣΕΙΣ ΚΑΙ ΤΙΣ ΛΟΙΠΕΣ ΣΧΕΤΙΚΕΣ ΔΙΑΤΑΞΕΙΣ ΤΗΣ ΟΔΗΓΙΑΣ CE/RED.
[HU] Hungarian	A TELTONIKA ezzennel kijelenti, hogy a RUTX12 típusú berendezés teljesíti az alapvető követelményeket és más CE/RED irányelvben meghatározott vonatkozó rendelkezéseket.
[IT] Italian	Con la presente TELTONIKA dichiara che questo RUTX12 è conforme ai requisiti essenziali ed alle altre disposizioni pertinenti stabilite dalla direttiva CE/RED.
[LT] Lithuanian	Šiuo dokumentu UAB TELTONIKA deklaruoja, kad šis RUTX12 atitinka esminius reikalavimus ir kitas CE/RED Direktyvos nuostatas.
[LV] Latvian	Ar šo TELTONIKA deklarē, ka RUTX12 atbilst Direktīvas CE/RED būtiskajām prasībām un citiem ar to saistītajiem noteikumiem.
[NL] Dutch	Hierbij verklaart TELTONIKA dat het toestel I RUTX12 in overeenstemming is met de essentiële eisen en de andere relevante bepalingen van richtlijn CE/RED.
[NO] Norwegian	TELTONIKA Erklærer herved at RUTX12 er i samsvar med de grunnleggende krav og øvrige relevante krav i direktiv CE/RED.
[PL] Polish	Niniejszym TELTONIKA deklaruje że RUTX12 jest zgodny z zasadniczymi wymaganiami i innymi właściwymi postanowieniami Dyrektywy CE/RED.
[PT] Portuguese	Eu, TELTONIKA declaro que o RUTX12 cumpre os requisitos essenciais e outras provisões relevantes da Directiva CE/RED.
[RO] Romanian	Prin prezenta, TELTONIKA declară că aparatul RUTX12 este în conformitate cu cerințele esențiale și cu alte prevederi pertinente ale Directivei CE/RED.
[SE] Swedish	Härmed intygar TELTONIKA att denna RUTX12 är i överensstämmelse med de väsentliga egenskapskrav och övriga relevanta bestämmelser som framgår av direktiv CE/RED.
[SI] Slovenian	TELTONIKA izjavlja, da je ta RUTX12 v skladu z bistvenimi zahtevami in drugimi relevantnimi določili direktive CE/RED.

The full text of the EU declaration of conformity is available at the following Internet address: https://wiki.teltonika-networks.com/view/RUTX12_CE/RED

- [EN]** Instruction Manual: Connect the power adapter to turn on the device. Open 192.168.1.1 in your web browser to configure it. More information on <https://wiki.teltonika-networks.com>
- [BG]** Инструкции: Свържете адаптера на захранване, за да включите устройството. Отворете 192.168.1.1 в уеб браузър, за да настроите продукта. Повече информация в <https://wiki.teltonika-networks.com>
- [CZ]** Návod k použití: Připojte napájecí adaptér k zapnutí přístroje. Otevřete 192.168.1.1 ve webovém prohlížeči pro konfiguraci produktu. Více informací najdete v <https://wiki.teltonika-networks.com>
- [DE]** Bedienungsanleitung: Verbinden Sie das Netzteil, um das Gerät einzuschalten. Öffnen Sie 192.168.1.1 in einem Web Browser, um das Produkt zu konfigurieren. Weitere Informationen im <https://wiki.teltonika-networks.com>
- [DK]** Instruktionsbog: Tilslut strømadapteren for at tænde for enheden. Åbn 192.168.1.1 i en webbrowser til at konfigurere produktet. Mere information i <https://wiki.teltonika-networks.com>
- [EE]** Kasutusjuhend: Ühendage toiteadapter seadme sisselülitamiseks. Avatud 192.168.1.1 in veebilehitseja seadistada toodet. Rohkem teavet <https://wiki.teltonika-networks.com>
- [ES]** Manual de instrucciones: Conecte el adaptador de alimentación para encender la unidad. Abra 192.168.1.1 en un navegador web para configurar el producto. Más información en <https://wiki.teltonika-networks.com>
- [FI]** Käyttöohje: Kytke virtalähde päälle laitteen. Avaa 192.168.1.1 selaimen määräättää tuotteen. Lisää tietoa <https://wiki.teltonika-networks.com>
- [FR]** Mode d'emploi: Connectez l'adaptateur d'alimentation pour allumer l'appareil. Ouvrez 192.168.1.1 dans un navigateur Web pour configurer le produit. Plus d'informations dans <https://wiki.teltonika-networks.com>
- [GR]** εγχειρίδιο οδηγών: Συνδέστε τον προσαρμογέα τροφοδοσίας για να ενεργοποιήσετε τη μονάδα. Ανοίξτε 192.168.1.1 σε ένα πρόγραμμα περιήγησης στο Web για να διαμορφώσετε το προϊόν. Περισσότερες πληροφορίες στο <https://wiki.teltonika-networks.com>
- [HU]** Használati utasítás: Csatlakoztassa a hálózati adaptert a készülék bekapcsolásához. Megnyitása 192.168.1.1 egy webböngészőben beállítani a terméket. Több információ <https://wiki.teltonika-networks.com>
- [IT]** Manuale di istruzioni: Collegare l'adattatore di alimentazione per accendere l'unità. Aprire 192.168.1.1 in un browser Web per configurare il prodotto. Maggiori informazioni in <https://wiki.teltonika-networks.com>
- [LT]** Naudojimosi instrukcija: Prijunkite maitinimo adapterį, įjunkite įrenginį. Interneto naršyklėje atidarykite adresą 192.168.1.1 - galite konfigūruoti gaminį. Daugiau informacijos rasite <https://wiki.teltonika-networks.com>
- [LV]** Lietošanas instrukcija: Pievienojiet Strāvas adapteri, lai ieslēgtu ierīci. Atvērt 192.168.1.1 ar interneta pārlūku, lai konfigurētu produktu. Plašāka informācija <https://wiki.teltonika-networks.com>
- [NL]** Handleiding: Sluit voedingsadapter aan op het apparaat in te schakelen. Open 192.168.1.1 in een webbrowser om het product te configureren. Meer informatie in <https://wiki.teltonika-networks.com>
- [NO]** Bruksanvisningen: Koble strømadapteren for å slå på enheten. Åpne 192.168.1.1 i en netleser for å konfigurere produktet. Mer informasjon på <https://wiki.teltonika-networks.com>
- [PL]** Instrukcja obsługi: Podłącz adapter zasilania, aby włączyć urządzenie. Otwórz 192.168.1.1 w przeglądarce internetowej, aby skonfigurować urządzenie. Więcej informacji w <https://wiki.teltonika-networks.com>
- [PT]** Manual de instruções: Conecte o adaptador de alimentação para ligar o aparelho. Abra 192.168.1.1 em um navegador da web para configurar o produto. Mais informações em <https://wiki.teltonika-networks.com>
- [RO]** Instrucțiuni de utilizare: Conectați adaptorul de alimentare pentru a porni aparatul. Deschide 192.168.1.1 întrun browser web pentru a configura produsul. Mai multe informații în <https://wiki.teltonika-networks.com>
- [SE]** Instruktionsmanual: Anslut nätadap tern för att slå på enheten. Öppna 192.168.1.1 i en webbläsare för att konfigurera produkten. Mer information på <https://wiki.teltonika-networks.com>
- [SI]** Navodila: Priključite napajalnik za vklop naprave. Odprite 192.168.1.1 v spletnem brskalniku nastaviti izdelek. Več informacij v <https://wiki.teltonika-networks.com>
- [SK]** Návozd na použitie: Pripojte napájací adaptér k zapnutiu prístroja. Otvorte 192.168.1.1 vo webovom prehliadači pre konfiguráciu produktu. Viac informácií nájdete v <https://wiki.teltonika-networks.com>

For more information visit www.teltonika-networks.com



This sign means that all used electronic and electric equipment should not be mixed with general household waste.



This sign means that product meets the requirements of the applicable EU directives.